

- 3/4-16 Stud Input w/ Nut
- BNC (Amphenol) Output

6X  $\phi$  .41 [ 10 ] THRU  
ON A 4.50 [ 114 ] BOLT CIRCLE

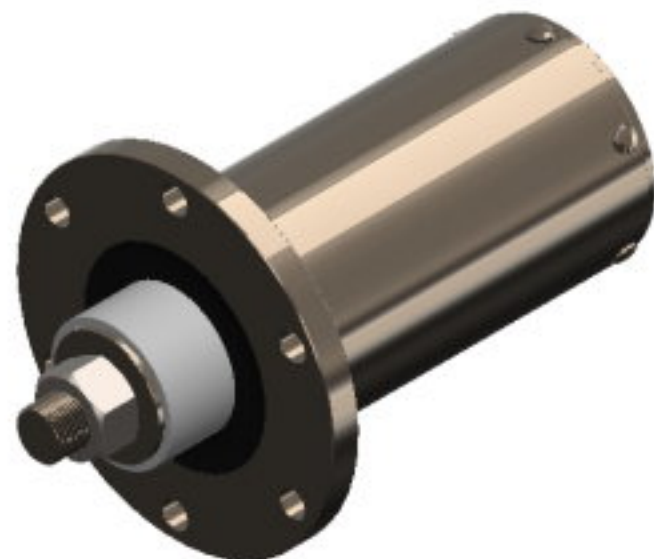

Specifications subject to change without notice.

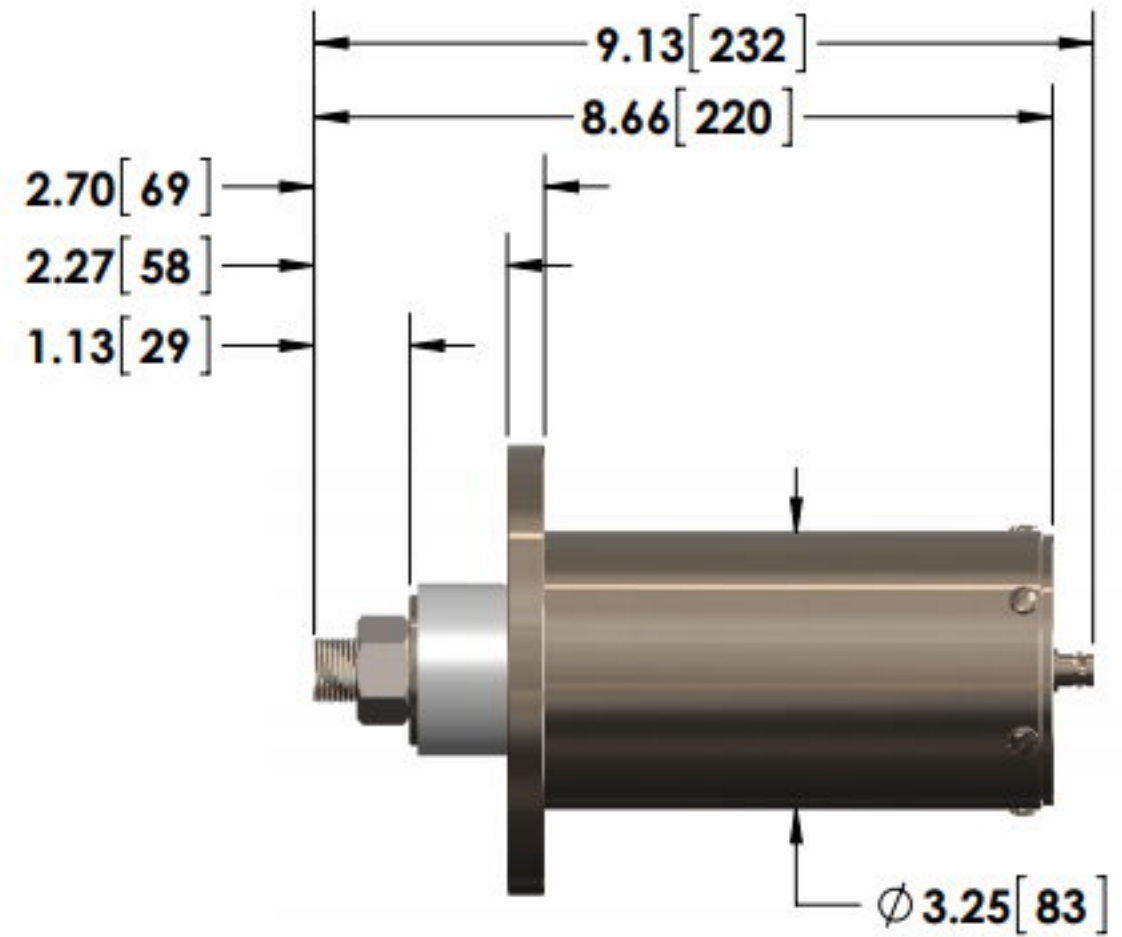
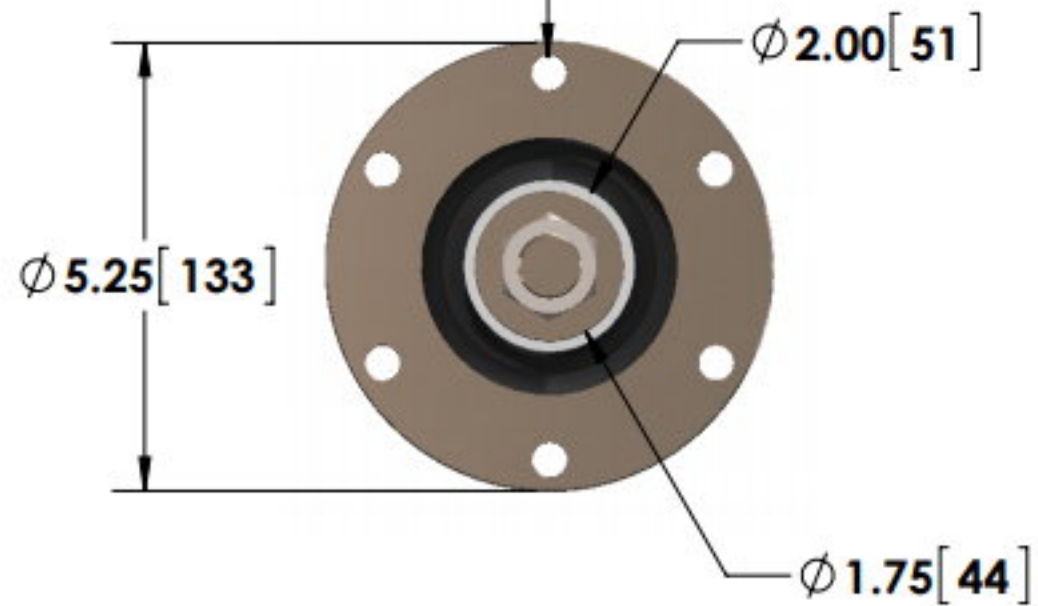

T & M RESEARCH PRODUCTS, INC.

TITLE: **K SERIES - 120 WATT UNIT**

DIMENSIONS: **inch[mm]**

DATE: **04-01-2015**