

- 3/4-16 Stud Input w/ Nut
- BNC (Amphenol) Output

6X ϕ .41 [10] THRU
ON A 4.50 [114] BOLT CIRCLE

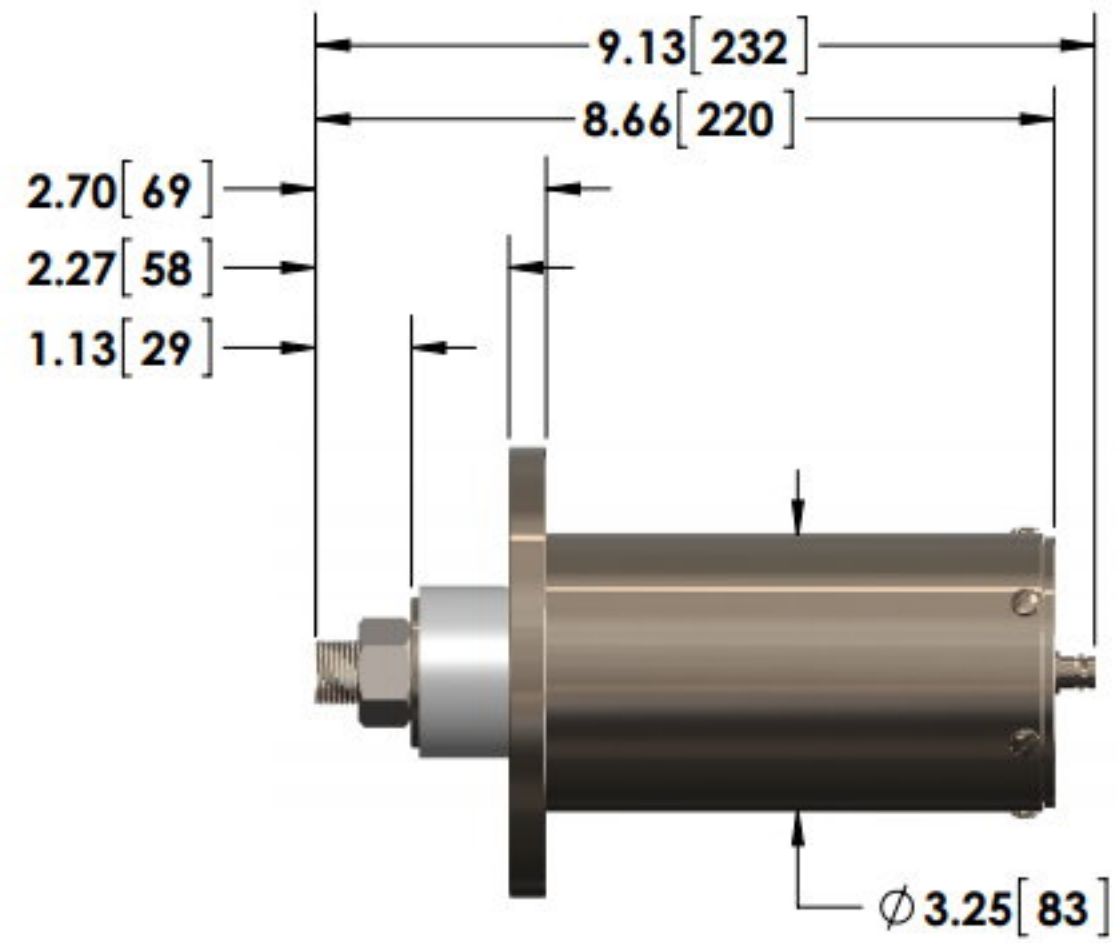

Specifications subject to change without notice.

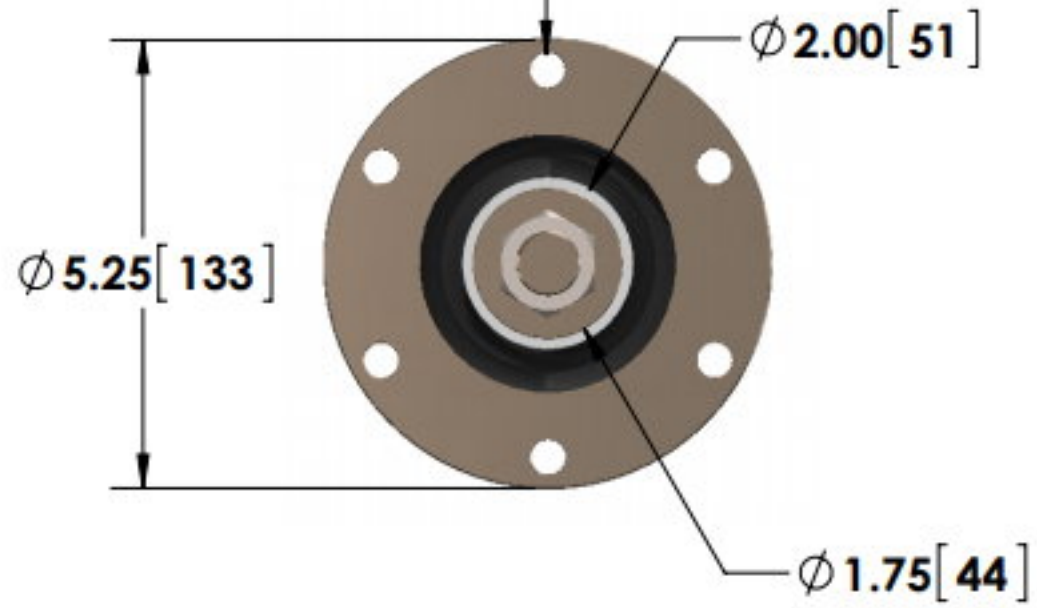

T & M RESEARCH PRODUCTS, INC.

TITLE: **K SERIES - 120 WATT UNIT**

DIMENSIONS: **inch[mm]**

DATE: **04-01-2015**